

R410A Addressable refrigerant gas sensor

SGI618

rev. 5

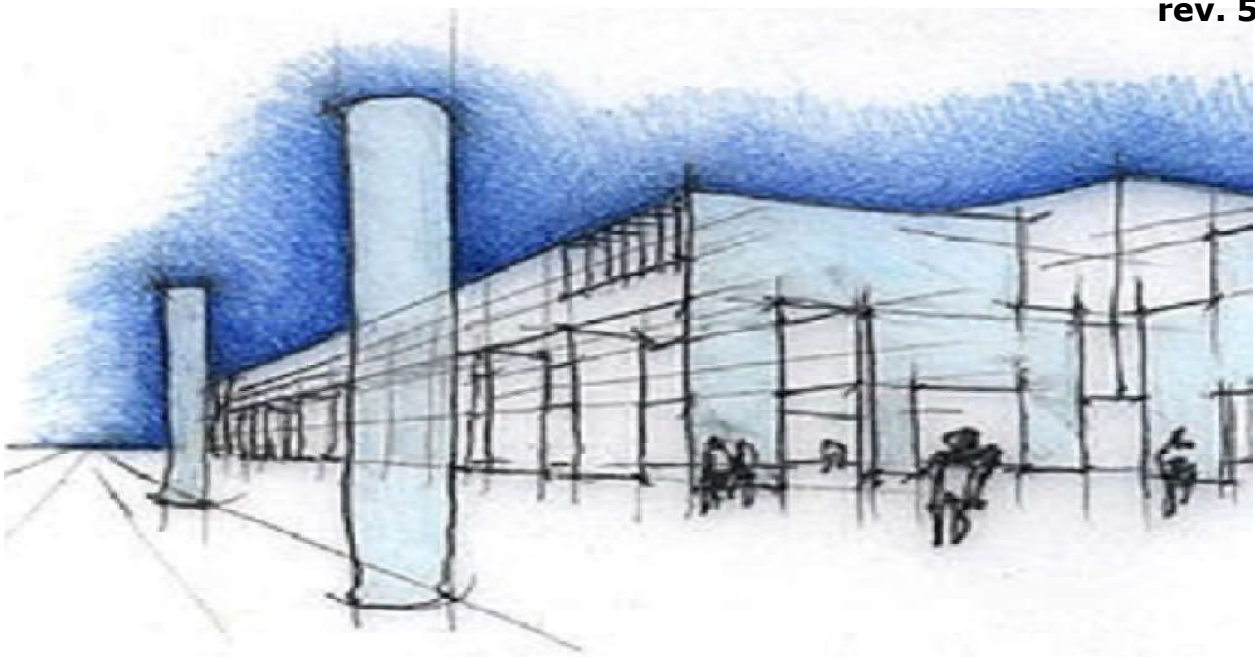

The addressable sensor **SGI618** is an IP55-rated semiconductor gas detection unit that, coupled with our addressable gas detection controller **BXI32**, allows to detect a refrigerant gas **R410A**

The sensor is managed by a microprocessor which not only supplies an alarm signal to the control unit connected to it, but also allows execution of a self-diagnosis and therefore an **AUTOMATIC CALIBRATION**, in order to always have the maximum detection accuracy.

The self-calibration means the probe adapts in harsh and variable temperature environments, avoiding false alarms due to anomalous events.
The probe has a MODBUS RS485 output.

Indispensable instrument for the annual check of the probes Instrument of testing TS1008

To facilitate the reading of the functional parameters of the probe as well as the control of annual operating, the **BEINAT S.r.l.** has built a new portable tester **TS1008**.

The tester allows to read all the data in the memory of the probes eand by serial transmission, it prints the ticket that confirms the testing data.



Important: Assembly / maintenance of the appliance must be carried out by qualified personnel and in accordance with applicable laws and regulations.
The manufacturer assumes no responsibility for the use of products that have to comply with particular environmental and / or installation standards.



Important note
Before connecting the equipment, it is recommended that you read the instruction manual carefully and keep it for future reference. It is also recommended to perform the electrical connections correctly as per enclosed drawings, observing the instructions and the Standards.
N.B. Refer to the documentation in all cases where the symbol is on the side



**Installation and user
guide**

CONFORMITY

EN 50270
Compliant EN 60079-29-1
Installation EN 60079-29-2
Reports issued by TUV Italia

Precautions

CHECK the integrity of the unit after having removed it from the box.
Check that the data written on the box correspond to the type of gas used.
When doing the electrical connections, follow the drawing closely.
Any use of the detector for purposes other than the intended one is considered improper, and as a result of which **BEINAT S.r.l.** therefore disclaims any responsibility for possible damages caused to people, animals or objects.

TERMS and EXPECTATIONS: The installation of the sensor **SGI618**, its ordinary and extraordinary maintenance, every six months, and its out of service removal at the end of the functional life guaranteed by the manufacturer, must be carried out by **authorized or specialized personnel.**

Do not allow it to become wet.

The control unit can be seriously damaged as it is not waterproof either when immersed in water or exposed to high levels of humidity.

Do not drop it.

Heavy knocks or falls during transportation or installation can damage the appliance.

Avoid abrupt temperature fluctuations.

Sudden temperature variations can cause condensation and the control unit could work poorly.

Cleaning. Never clean the device with chemical products. If necessary, wash with a moist cloth.



Technical Specifications

Power Supply **12÷24VDC** ± 10%
Power demand 90 mA in operating, 160 mA in alarm Max @ 13,8 V
Leds..... **green light normal operation, yellow light fault, red light alarm**
Data transmission LED **RX TX**

Alarm/Fault relay: 5A SELV 30 VDC
Detection **Freon R410A**
Sensor Semiconductor
Alarm intervention:..... Linear from 0 to 300 ppm
Selection of the operating Range 0 ÷ 999 ppm
Data transmission signal **Serial RS485 protocol ModBUSRTU**

Detector accuracy 1% FS
Long term shift in clean air < 3% of LEL
Auto zero procedure Included in the software algorithms
USB test plug..... **TS1008**
Response Time <10"
Warm-up time 1 minute
Functioning humidity 0-90% non condensed
Functioning temperature -10°C to +50°C

Suitable ECU **BX132**
Maximum distance between sensors and control unit1000 m
Cable diameter for connecting sensors0,50 mm²
Connection: **The cable of connection of the probe must not be installed together with the power cables. Otherwise, make sure to use a shielded cable**

InstallationWall mounting
Probe's body material ABS
Protection degree **IP55**
Size78x114x58 mm

Addressable refrigerant gas sensors **SGI6XX**

Code	Type of Gas	Sensor	Working range	Temperature
SGI615	Freon R134a	Semiconductor	999 ppm	-20+60°C
SGI616	Freon R404	Semiconductor	999 ppm	-20+60°C
SGI617	Freon R407C	Semiconductor	999 ppm	-20+60°C
SGI618	Freon R410A	Semiconductor	999 ppm	-20+60°C
SGI619	Freon R32	Semiconductor	999 ppm	-20+60°C
SGI620	Freon R507	Semiconductor	999 ppm	-20+60°C
SGI621	Freon R290	Semiconductor	999 ppm	-20+60°C

WARNING!

The sensor **SEMICONDUCTOR** has a duration that can vary from about 5 to 6 years in clean air.
The working temperature of the probe varies from **-20°C to+ 60°C.**

It must do the test of the detector simulating the gas detection using a pre-calibrated gas spray.

N.B.

The operation test and eventual calibrations must be performed at least 1 time a year by qualified technician

Compatible control units

CONTROL UNITS	MOUNTING	PROBES Max.	DEGREE protec.	PRE alarms	ALARMS	POSITIVE safety	OPERATING range
BXI32 unit 2 zones	Rail DIN	16	IP20	1	2	YES	YES
BXI32/Box unit 2 zones	Wall	16	IP65	1	2	YES	YES

MAINTENANCE



The user periodically (every 6 months) must perform a check of the operation of the control unit by spraying a suitable test gas at the base of the probes connected until the alarm condition is reached.

- At least once a year make a more accurate check by a specialist technician.
- Disabling the detector must be carried out by qualified personnel.

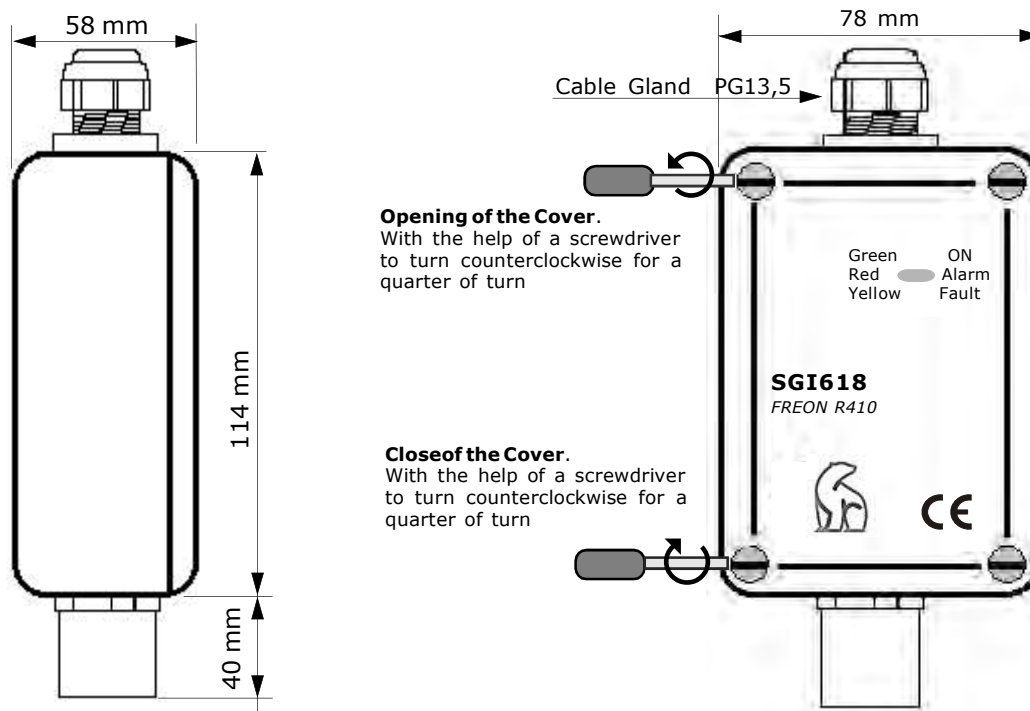

The installation of the detector is not exempt from The compliance with all regulations concerning the characteristics, installation and use of gas appliances. The ventilation of the spaces and the elimination of combustion products are described in the UNI norms according to ART. 3 LAW 1083 / 71 and relevant legal provisions.

Freon R134a	Semiconductor	999 ppm	-20+60°C
Freon R404A	Semiconductor	999 ppm	-20+60°C
Freon R407C	Semiconductor	999 ppm	-20+60°C

Positioning of the Probe

The position of the probe is a crucial factor for a gas detection unit correct functioning. In order to obtain the maximum results from an appliance and minimize the probabilities of false alarms, we recommend to follow this diagram and to keep in mind the following general rules. The remote probe must be located at different heights, according to the type of gas. These heights are:

- **30 cm** from the lowest point of the floor in order to detect **Heavy Gases : FREON**

The probe **must not be placed** near the following: furnaces, fuel-burning kitchen appliances, fireplaces, ranges, suction fans, and should not be affected by smoke, vapour as these could distort its measurement.

The probe **must not be placed** away from sources of heat, suction fans, ventilation fans, windows, doors, etc. that can distorting the detection, should be placed away from heat sources and away from aspirators or fans.

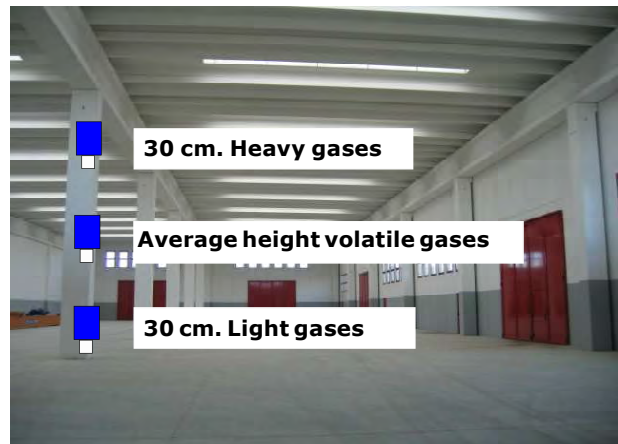
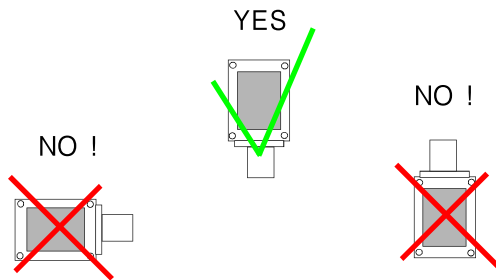

Detection Diagrams Data

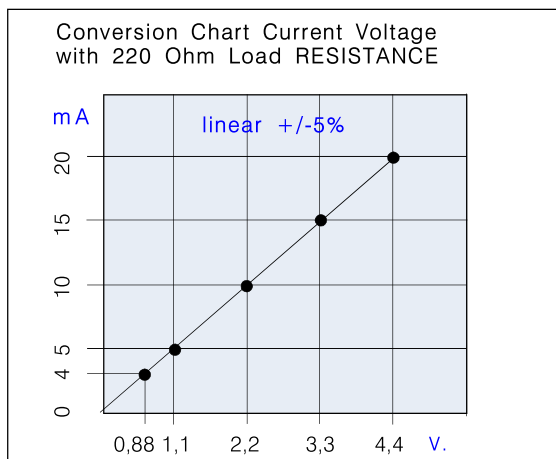
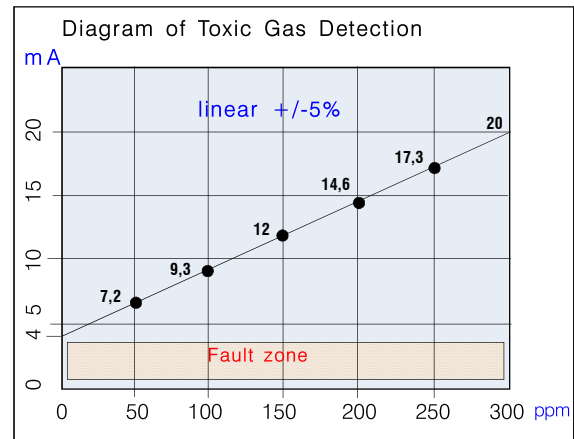
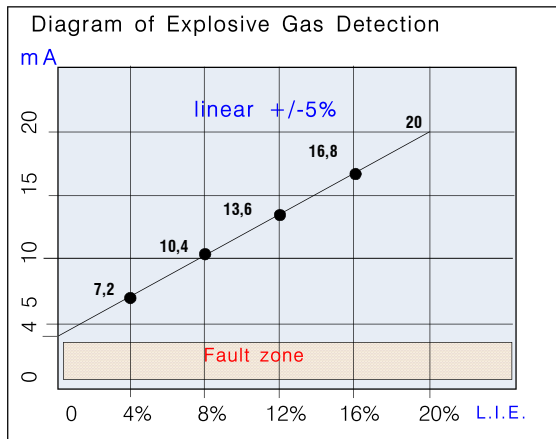

Electrical connections

WARNING

Before connecting to the mains power, ensure the voltage is correct. Carefully follow the instructions and the connections according to Regulations in force, keeping in mind that the signal cables should be laid separate from the power cables.

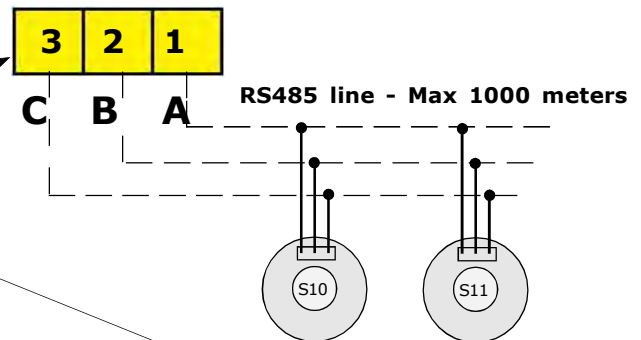
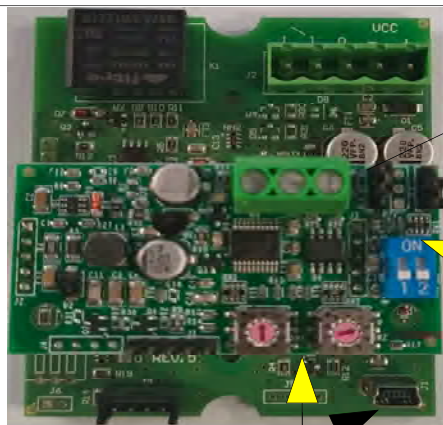
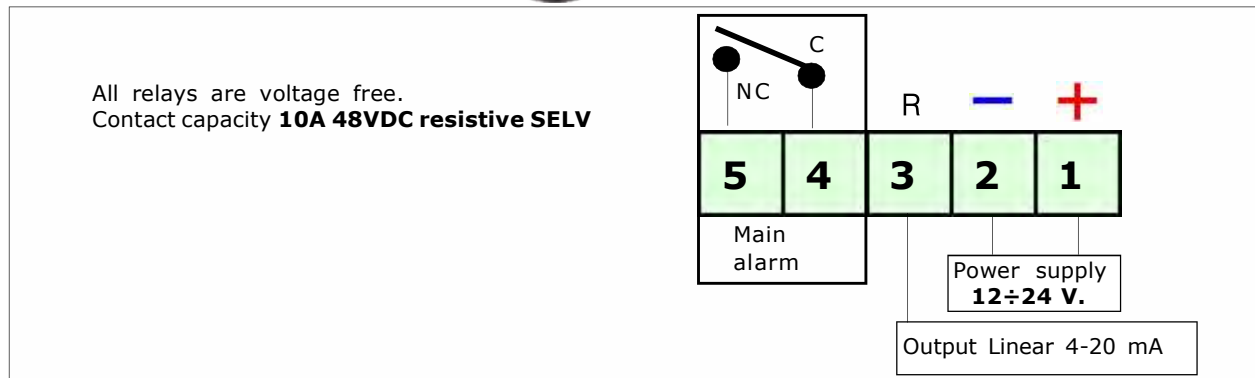
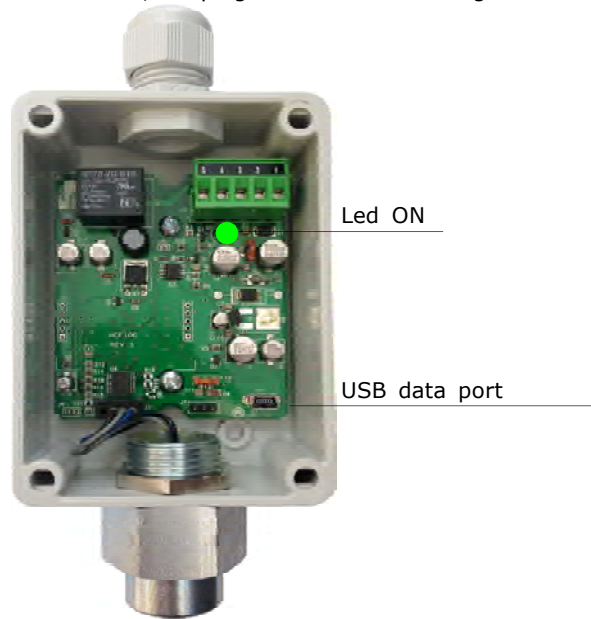

Each connected Probe must have a unique address so as not to create conflicts in the data transmission.

To enter the addresses of each **probe** or **board** you must act through the rotary switches of each **device**, up to a maximum of 32 addresses.



Tens



Unit

Example

Turn the tens switch until you find the desired Ten, example: 1
Turn the Unit Switch until you find the desired unit, for example: 6
By doing so you will get as address "16"
Remember to insert the end of line closure to the last probe or card

R.T. Line end Jumper
This Jumper must be in ON position at the last DEVICE of the line



Troubleshooting before calling a technician

Attention!!

The regulations described in this paragraph must be performed by an authorized and specialized technician and are susceptible to compromise the safety of the survey.

If the device does not start up.

Check that the **12 ÷ 24 VDC** power is present, and that positive and negative polarity has not been inverted.

If the Fault LED lights up.

If the fault signal reaches the control unit connected to the probe.

Check that the cables are connected according to the drawing, and that the wire isolation sheath has not been pinched.

Check the voltage at the terminals 1-2. It must be higher than 11 VDC and lesser than 25 VDC.

Check the voltage at the terminals 2-3. It must be from a minimum of 0.8 VDC to a maximum of 1.1 VDC

If other problems arise, a specialised and/or authorised technician and/or the Distributor of **BEINAT S.r.l.** should be contacted directly.

Gas Input Test

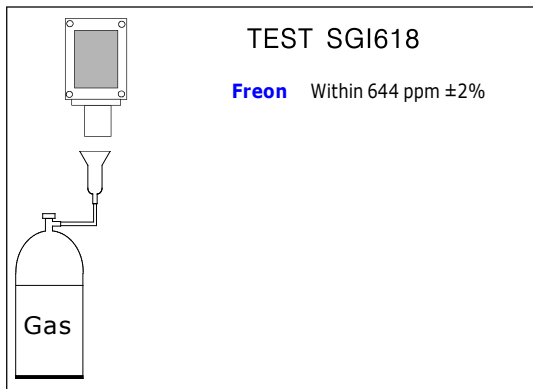

The installation of the **SGI618** probe, its ordinary and extraordinary maintenance, and its out of service removal at the end of the functional life guaranteed by the manufacturer, must be carried out by authorized or specialized personnel.

The general test should be performed by issuing gas from a pre-calibrated aerosol within the percentages illustrated on the side.

Important: This test must be carried out at least once a year.

WARNING! Actions to be taken in case of alarm

WARNING! Actions to be taken in case of alarm

Gas

- 1) Put out all free flames.
- 2) Close the main gas tap or the LPG cylinder tap.
- 3) Do not turn any lights on or off; do not turn on any electrical device or appliance.
- 4) Open windows and doors in order to increase ventilation.

If the alarm stops, its cause must be found and the relevant consequent measures taken.

If the alarm continues and the cause of gas presence cannot be found or removed, abandon the building and call the emergency services when outside (fire department, distributors, etc.)

IMPORTANT: The operation test should not be carried out with the gas tap as this does not guarantee a sufficient concentration to activate the general alarm.

Warning!!

If you have the following symptoms: vomiting, sleepiness, or else, go to the closest first aid station and inform the operators that you could have been poisoned by **Refrigerant Freon, or by an excess or deficiency of oxygen**



INSURANCE. This device is insured by the SOCIETÀ REALE MUTUA for the PRODUCT'S GENERAL LIABILITY up to a maximum of 1,500,000.00 EURO against damages caused by the device in case of failures in functioning.

WARRANTY. The warranty term is 3 years from manufacturing date, in agreement with the following conditions. The components acknowledged as faulty will be replaced free of charge, excluding the replacement of plastic or aluminium cases, bags, packing, batteries and technical reports.

The device must arrive free of shipment charges to **BEINAT S.r.l.**

Defects caused by unauthorized personnel tampering, incorrect installation and negligence resulting from phenomena outside normal functioning shall be excluded from the warranty.

BEINAT S.r.l. is not liable for possible damage, direct or indirect, to people, animals, or things; from product faults and from its enforced suspension of use.



DISPOSAL OF OLD ELECTRICAL & ELECTRONIC EQUIPMENT.

This symbol on the product or its packaging indicates that this product shall not be treated as household waste. Instead, it shall be handed over to the applicable collection point for the recycling of electrical and electronic equipment, such as for example:

- sales points, in case you buy a new and similar product
- local collection points (waste collection center, local recycling center, etc...).

By ensuring this product is disposed of correctly, you will help prevent potential negative consequence for the environment and human health, which could otherwise be caused by inappropriate waste handling of this product. The recycling of materials will help to conserve natural resources. For more detailed information about recycling of this product, please contact your local city office, your household waste disposal service or the shop where you purchased the product.

Attention: in some countries of the European Union, the product is not included in the field of application of the National Law that applies the European Directive 2002/96/EC and therefore these countries have no obligation to carry out a separate collection at the "end of life" of the product.



Made in Italy

Addressable freon gas sensor R410A **SGI618**

Lo styling è della b & b design

Stamp and signature of the dealer

Purchase date:

Matricola:

The Beinat S.r.l. following the targhet to improve its products, reserves the right to modify the technical features, aesthetic and functional any time without prior notice.

BEINATS.r.l.

Via Fatebenefratelli 122/C 10077, S. Maurizio C/se (TO) - ITALY

Tel. 011.921.04.84 - Fax 011.921.14.77

[http:// www.beinat.com](http://www.beinat.com)



Business - info@beinat.com

Help Desk - laboratorio@beinat.com